

Model No. : AR-NI1-1-S120-CXX, AR-NI1-1H120-TXX
Product Name : HVC 180° 1POS 12mm Metallic Connector (400A series)

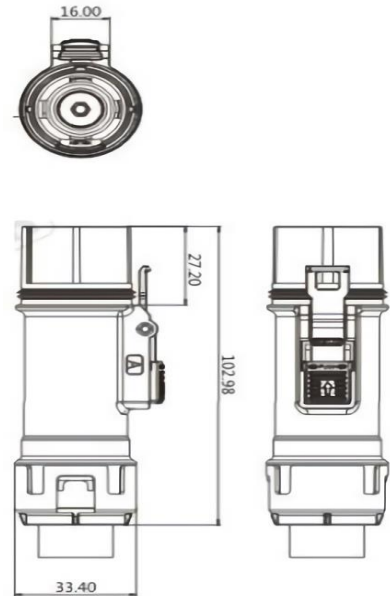
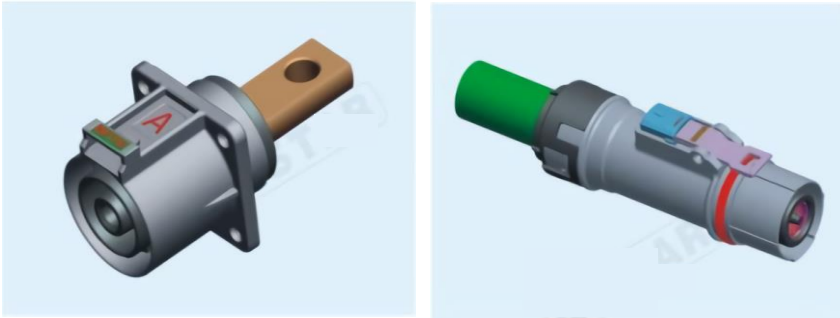

Application :

- PDU, Battery, Motor, Motor Controller

Description :

- Rated Voltage : 800V AC/DC
- Rated Current : From 300A to 400A
- Insulation resistance : $\geq 500M\Omega$
- Withstand voltage : 3500VAC
- Operating Temperature : $-40^{\circ}C \sim 125^{\circ}C$
- Cable range : 95mm-120mm² wire
- Shielding : 360° shielding
- Mating Cycles : >100
- IP Class : IP67, IP6K9K (Mated)
- Number of Positions : 1 POS
- HVIL

Performance :

- 12mm pin
- Excellent Electrical Insulation
- Secondary buckle
- Various Wire Diameter Application
- Multi Misplug-proof and key position design

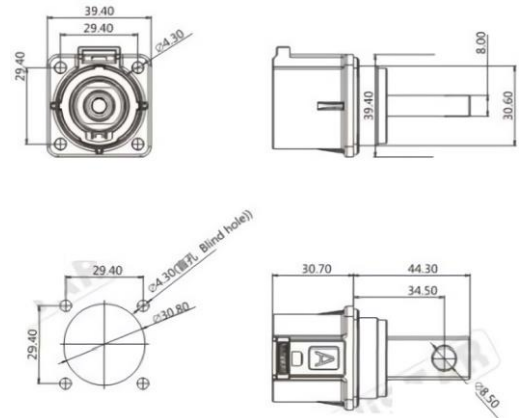

Part Number Information

Straight Plug	Pos Number	Key	HVIL	Color	Wire Spec
NI1-1-S120-	1	A	Y/N	A	C12 (95mm ²)
		Y		B	C14 (120mm ²)
		U		Y	/
		V		G	/
		W		R	/

Receptacle	Pos Number	Key	HVIL	Color	Wire Spec
NI1-1-H120-	1	A	Y/N	A	T05 (Ø10mm Through-hole)
		Y		B	T09 (M10 Screwed hole)
		U		Y	Customizable aperture size
		V		G	/
		W		R	/

Note : Color code A stands for Orange, B stands for Black, Y stands for Yellow, G stand for Green, R stands for Red.